



N32U DIGITAL PANEL METER

- Multi-purpose input for measuring: temperature, resistance, standard signals.
- Two-line LCD display with high contrast and built-in backlighting.
- Possibility of displaying the measured value and time simultaneously or an uncalculated quantity or unit (programmable unit of measured quantity).
- Meter programming from keyboard or through the RS-485 interface by means of the free eCon software.
- 4 alarm outputs with signalling on LED diodes, working in 7 different modes (option).
- Conversion of any measured value into an analog signal 0/4...20 mA or 0...10 V (option).
- Storage of minimal and maximal values for all measured quantities.
- Supply of object transducers.
- 32-point individual characteristic for the measured value.
- Mathematical functions for converting the measured value.

FEATURES	INPUTS	OUTPUTS	GALVANIC ISOLATION

DATA VISUALISATION



lub

Two-line display.
Simultaneous preview of the measured value (top line) and the input signal not scaled (bottom line).



lub

Programmable measurement unit
chosen from 56 variants available
in the menu.



Preview of current time
on the bottom line of the display.
Real-time clock with automatic winter/
summer time change function.

INPUT SCALING

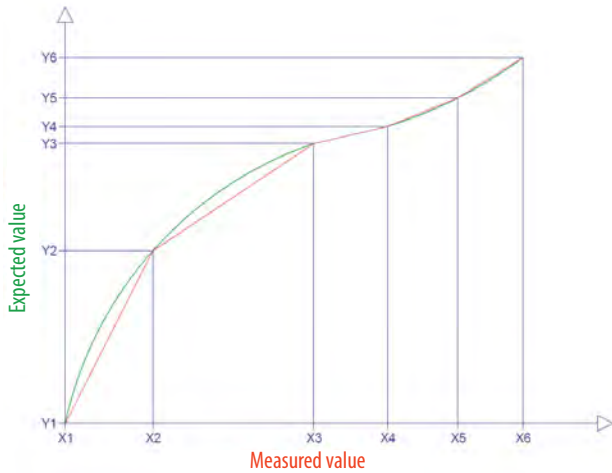

Conversion of the measured quantity based on 32-point individual characteristics. It allows for the mapping of signals from objects or sensors with non-linear characteristics.

$$\sqrt{x} \quad x^2 \quad (1/x)^2$$

$$\sqrt{(1/x)} \quad 1/x$$

Conversion of the measured quantity by means of mathematical functions: \sqrt{x} , x^2 , $1/x$, $(1/x)^2$, $\sqrt{(1/x)}$

ALARM FUNCTIONS



1 or 4 relay outputs with the indication on the display as an active alarm number.

Each alarm can be configured to operate in one of 7 modes, including REG mode for alarm control through RS-485 Modbus.

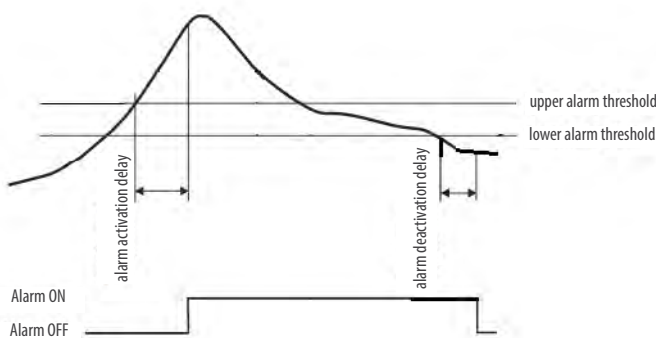

Programmable alarm signal holding. Once the alarm event has ceased, the alarm status marker flashes on the display until it is reset by the user.

Individually programmable parameters for alarm activation and deactivation delay; the function can be used to prevent "false" alarms.

$t \geq \text{time delay} \rightarrow$ Alarm activated
For alarm operation both conditions (value and time delay) must be met

ADVANCED MEASUREMENT CONVERSION FUNCTION

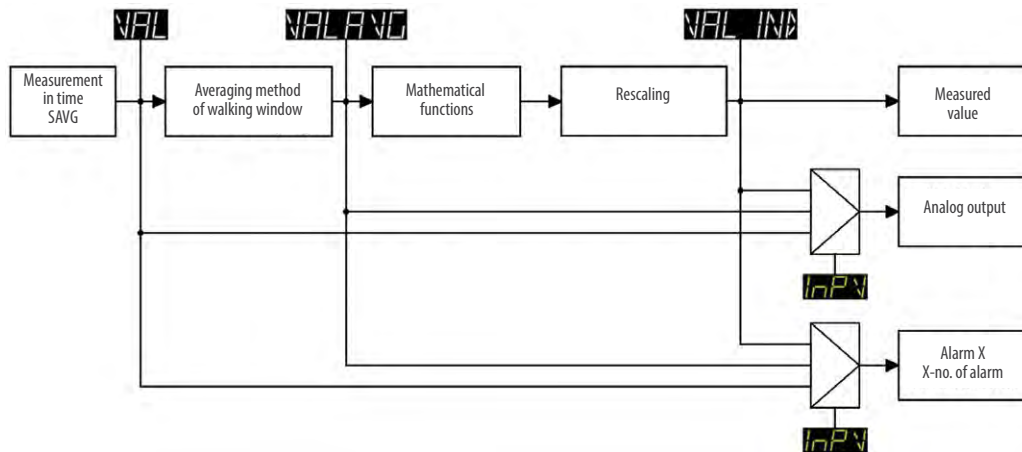

The measured value can be converted in series and the result can be displayed. After each conversion step, the signal can be used for retransmission on the analogue output or as an alarm source.

In practical use, the meter can read the value from an object-oriented transmitter and display the actual value within a limited range, e.g. pressure, level, etc. At the same time, the input signal not scaled can be retransmitted to the PLC.

This function can be useful in applications where the signal is dynamic. The display can show the values averaged over time (easier signal observation). On the analogue output instead, you can retransmit the signal without additional delays - this also applies to the alarm outputs.

WALKING WINDOW ALGORITHM

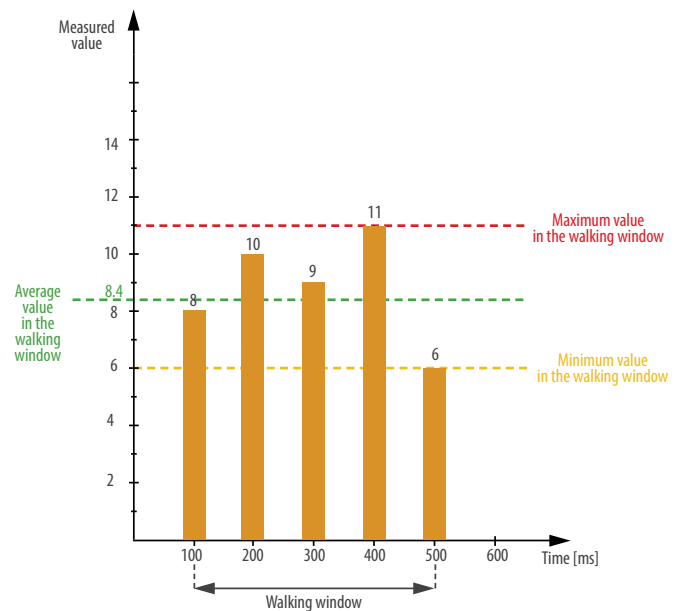
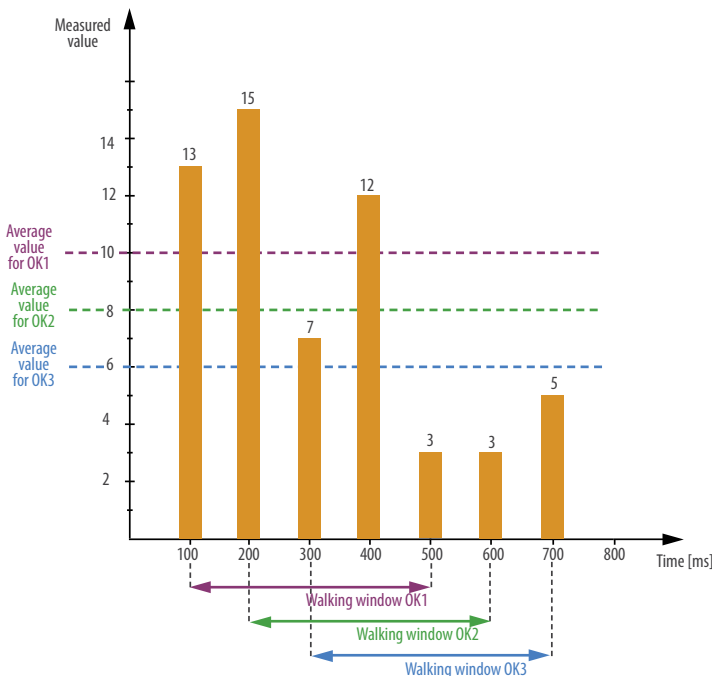

Programmed averaging time according to the walking window algorithm with a set averaging time. This function is useful for measuring high-dynamic signals.

Ability to measure the average, minimum or maximum value when displaying the walking window.

TECHNICAL DATA

INPUTS

Input type	Maximal measuring range	Class	Basic error
Pt100	-205...855°C (-200...850°C)	0.1	- due to automatic compensation of the reference junction temperature <1°C - due to automatic compensation of the cable resistance for thermoresistors < 0.5°C - due to automatic compensation of the cables for resistance measurement < 0.2 Ω - from temperature changes 50 % of the class/ 10 K
Pt1000	-205...855°C (-200...850°C)		
400 Ω	0...410 Ω (0...400 Ω)		
4000 Ω	0...4010 Ω (0...4000 Ω)		
Thermocouple of J type	-200...1200 °C (-100...1200 °C)		
Thermocouple of K type	-200...1370 °C (-100...1370 °C)		
Thermocouple of N type	-200...1300 °C (-100...1300 °C)		
Thermocouple of E type	-200...1000 °C (-100...1000 °C)		
Thermocouple of R type	-50...1768 °C (-50...1760 °C)		
Thermocouple of S type	-50...1768 °C (-50...1760 °C)		
Voltage input 10 V	-13...13 V (-10...10 V)		
Current input 20mA	-24...24 mA (-20...20 mA)		
Current input 4...20 mA	3.6...22.0 mA (4...20 mA)		
Voltage input 60 mV	-10...63 mV (0...60 mV)		
Voltage input 150 mV	-155...155 mV (-150...150 mV)		
Voltage input 300 mV	-310...310 mV (-300...300 mV)		
Current time	00.00...23.59	+/-20 ppm	

OUTPUTS

Output type	Properties	Remarks
Relay output	<ul style="list-style-type: none"> 1 x NO contacts, load-carrying capacity 5A / 250 V a.c.; 5A / 30V d.c. 3 relays with changeover contact, load-carrying capacity 6A / 250V a.c.; 6A / 30V d.c.; 0,15A / 250V d.c. 	
Analog output	<ul style="list-style-type: none"> current programmable 0/4...20 mA, load resistance ≤ 500 Ω voltage programmable 0...10 V, load resistance ≥ 500 Ω 	Error of analog output: 0.1% of the set range Additional error from temperature changes: 50% of the class/10K
OC output	OC type, passive npn, 30 V d.c./30 mA	voltageless output
Auxiliary supply	24 V d.c./ 30mA	

DIGITAL INTERFACE

Interface type	Transmission protocol	Mode	Baud rate
RS-485	MODBUS RTU	8N2, 8E1, 801, 8N1	2.4, 4.8, 9.6, 14.4, 19.2, 28.8, 38.4, 57.6, 115.2 kbit/s

EXTERNAL FEATURES

Readout field	1 row: 6-digits; digits height 12.85 mm 2 row: 5-digits; digits height 7.5 mm	high contrast LCD with backlight and programmable measuring unit
Weight	< 0.25 kg	
Overall dimensions	96 x 48 x 93 mm	mounting hole 92 ^{+0.6} x 45 ^{+0.6} mm
Protection grade (acc. to EN 60529)	from frontal side: IP65	from terminal side: IP 10

RATED OPERATING CONDITIONS

Supply voltage	85...253 V a.c. (40...400 Hz), 90...300 V d.c. 20...40 V a.c. (45...65 Hz) / 20...60 V d.c.	power consumption < 6 VA
Temperature	ambient: -25...23...55°C	storage: -30...70°C
Relative humidity	25...95%	without condensation
Operating position	any	
External magnetic field	0...400 A/m	

SAFETY AND COMPABILITY REQUIREMENTS

Electromagnetic compatibility	noise immunity	acc. to EN 61000-6-2
	noise emissions	acc. to EN 61000-6-4
Isolation between circuits	basic	acc. to EN 61010-1
Pollution level	2	
Installation category	III	
Maximal phase-to-earth voltage	for supply circuits : 300 V	
	for other circuits: 50 V	
Altitude a.s.l.	< 2000 m	

CONNECTION DIAGRAMS

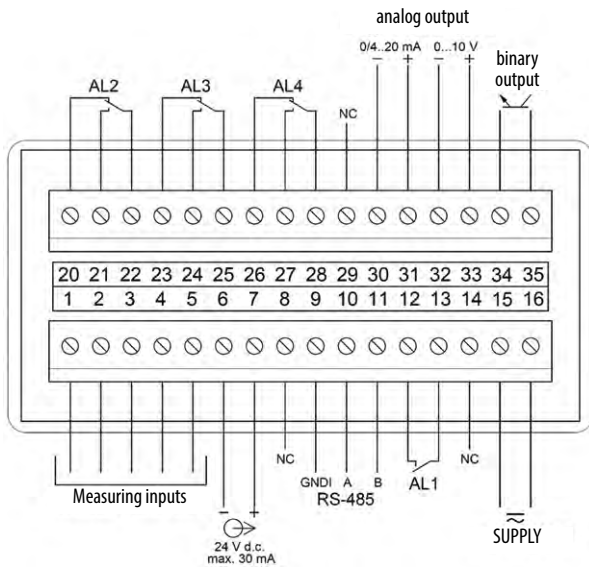

Description of signals on the connection strips

Standard signals 0...10 V
(range -13...13 V)

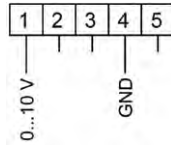

Standard signals 0/4...20 mA
(range -24...24 mA)

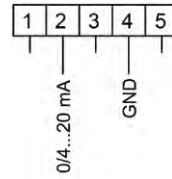

Thermocouples, thermoelectric sensors (thermocouple)

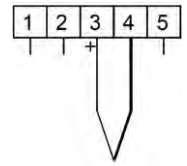

Standard shunts: 60 mV, 150 mV, 300 mV
(measuring range respectively:
-75...75 mV, -155...155 mV,
-310...310 mV)

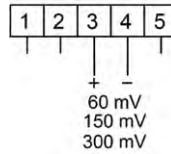

Resistance sensors or resistor
in a three-wire system

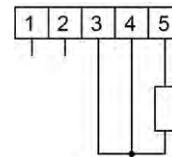

Resistance sensors or resistor
in a two-wire system

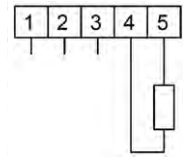

Meter connection

ORDERING CODE

N32U	X	X	XXXXXXX	X	X
Supply:					
85...253 V a.c., 90...300 V d.c.	1				
20...40 V a.c./ 20...60 V d.c.	2				
Additional outputs:					
1 relay output, RS-485		1			
4 relay outputs, RS-485		2			
4 relay outputs, RS-485, 1 analog output		3			
Version:					
standard			0000000		
custom-made*			XXXXXXX		
Language:					
Polish/English					M
Acceptance tests:					
without additional quality requirements					0
with an extra quality inspection certificate					1
with an extra calibration certificate					2
acc. to customer's request					X

ORDERING EXAMPLE:

N32U 13000000M0 means N32U meter with supply 85... 253 V a.c., 90...300 V d.c., with 4 relay outputs, RS-485 interface and 1 analog output, in standard version, polish-english language version, without additional quality requirements.

* only after agreeing with the manufacturer